

LTE Radio Physical Layer

Sadayuki Abeta
NTT DOCOMO



Contents



Introduction

 Downlink Aspects for LTE Release 8

 Uplink Aspects for LTE Release 8

 Enhancements for LTE-Advanced (Release 10 and beyond)



Physical Layer Specifications



- 📶 TS 36.201 E-UTRA Physical layer: General description .
- 📶 TS 36.211 E-UTRA Physical channels and modulation .
- 📶 TS 36.212 E-UTRA Multiplexing and channel coding .
- 📶 TS 36.213 E-UTRA Physical layer procedures .
- 📶 TS 36.214 E-UTRA Physical layer - Measurements
- 📶 The latest version of the specifications can be downloaded from:
 - <http://www.3gpp.org/ftp/Specs/>



LTE Release 8 Major Parameters



THE Mobile Broadband Standard

Access Scheme	DL	OFDMA
	UL	SC-FDMA
Bandwidth	1.4, 3, 5, 10, 15, 20 MHz	
Minimum TTI	1 ms	
Sub-carrier spacing	15 kHz	
Cyclic prefix length	Short	4.7 μs
	Long	16.7 μs
Modulation	QPSK, 16QAM, 64QAM	
Spatial multiplexing	Single layer for UL per UE Up to 4 layers for DL per UE MU-MIMO supported for UL and DL	



Transmission Resource structure

- 📶 Basic unit of resource is the **Physical Resource Block (PRB)**
- 📶 12 sub-carriers x 0.5 ms
- 📶 Allocated in pairs (in time domain)
- 📶 1 sub-carrier x 1 symbol = 1 resource element (RE)
- 📶 Spatial domain measured in “**layers**”

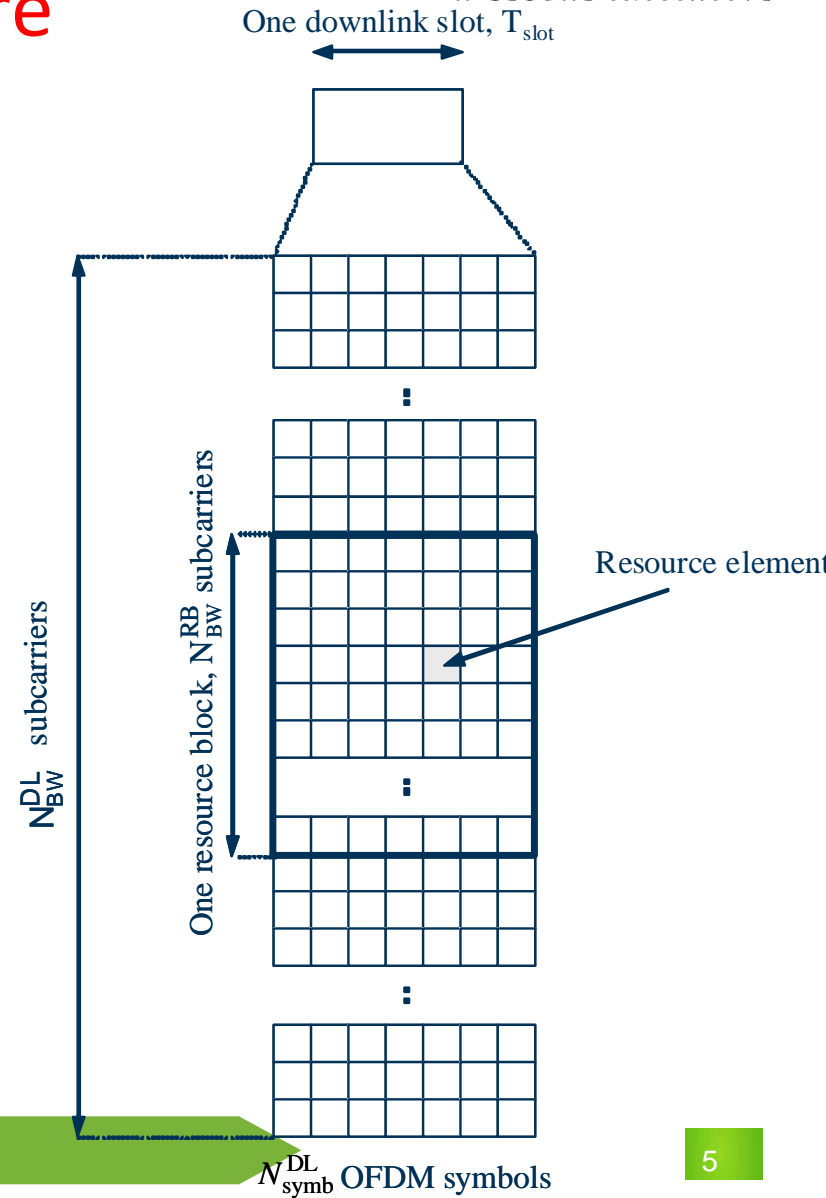



One radio interface for FDD and TDD



Supports both FDD and TDD

- FDD

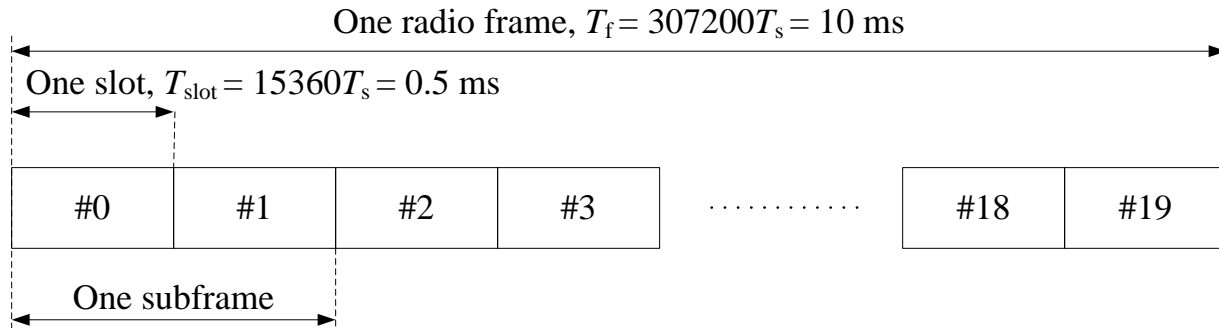

- TDD

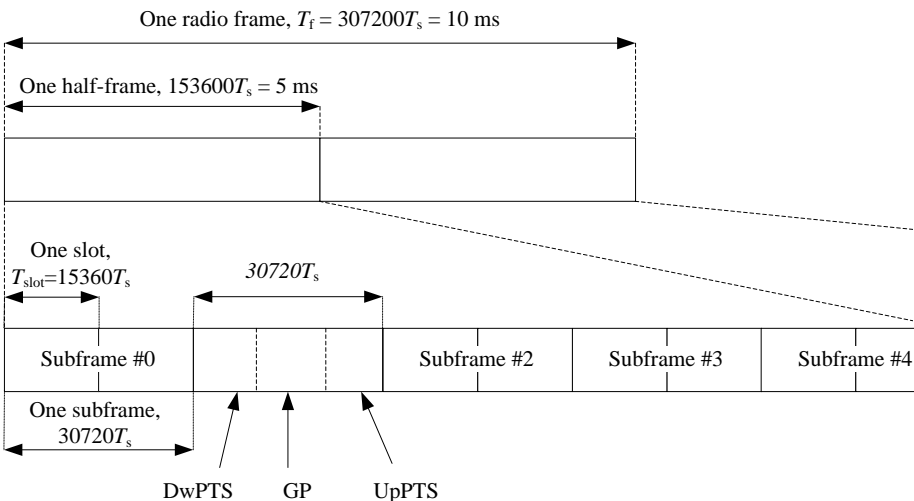

Uplink-downlink configuration	Subframe number									
	0	1	2	3	4	5	6	7	8	9
0	D	S	U	U	U	D	S	U	U	U
1	D	S	U	U	D	D	S	U	U	D
2	D	S	U	D	D	D	S	U	D	D
3	D	S	U	U	U	D	D	D	D	D
4	D	S	U	U	D	D	D	D	D	D
5	D	S	U	D	D	D	D	D	D	D
6	D	S	U	U	U	D	S	U	U	D



Contents



 Introduction

 **Downlink Aspects for LTE Release 8**

 Uplink Aspects for LTE Release 8

 Enhancements for LTE-Advanced (Release 10 and beyond)



THE Mobile Broadband Standard

Cell acquisition signalling

- Synchronisation signals (SS) in subframes 0 and 5 of each 10 ms radio frame
 - Used in initial cell search
 - Common scheme irrespective to bandwidth simplify the procedure
- Physical broadcast channel (PBCH) in subframe 0 of each radio frame
 - Carries the Master Information Block (MIB)
 - Includes indication of system bandwidth
 - Robust design for cell-wide coverage:
 - Low rate, QPSK, robust channel coding (1/3-rate tail-biting convolutional code with repetition), 40 ms TTI
 - CRC indicates number of transmit antennas (SS and PBCH are transparent to number of antenna)

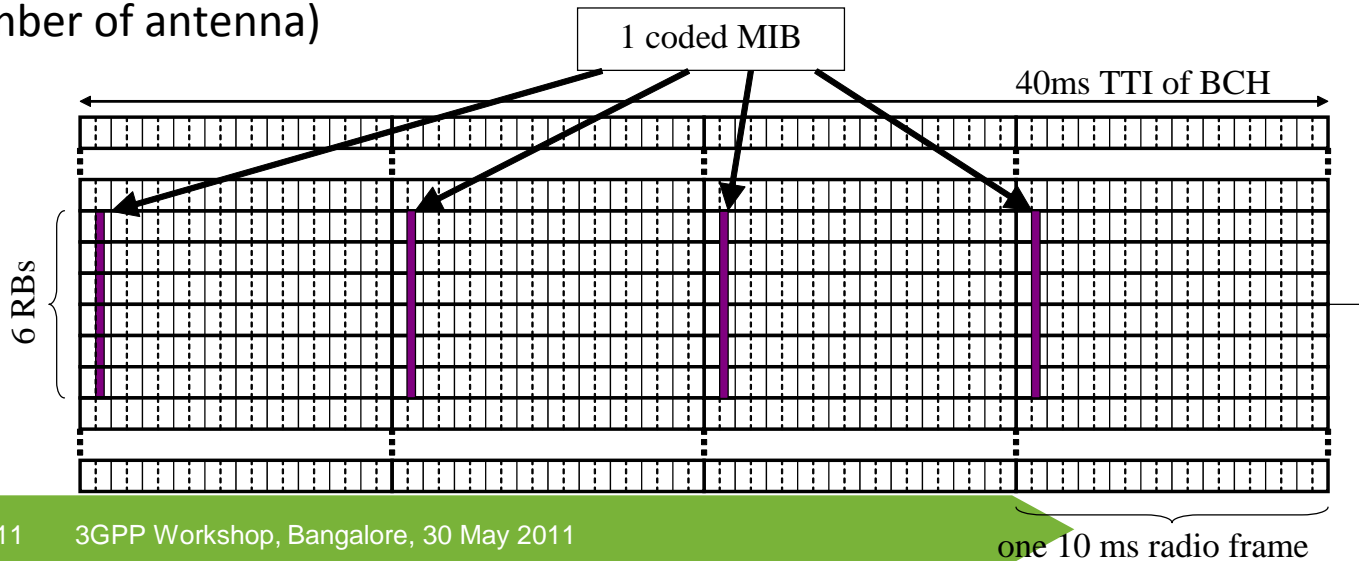



Reference Signals (RS)



In Rel-8, cell-specific RS are provided for 1, 2 or 4 antenna ports

- Pattern designed for effective channel estimation
 - Sparse diamond pattern supports frequency-selective channels and high-mobility with low overhead
- Up to 6 cell-specific frequency shifts are configurable
- Power-boosting can be applied on the REs used for RS
- QPSK sequence with low PAPR

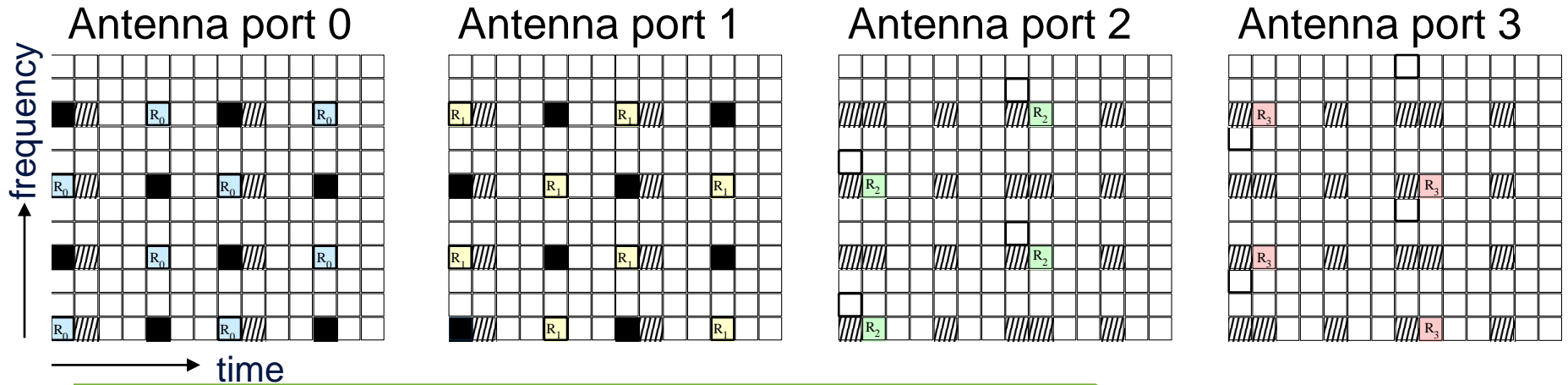



UE-specific Reference Signals



In Rel-8:

- UE-specific (precoded) RS may be provided in data transmissions to specific UEs

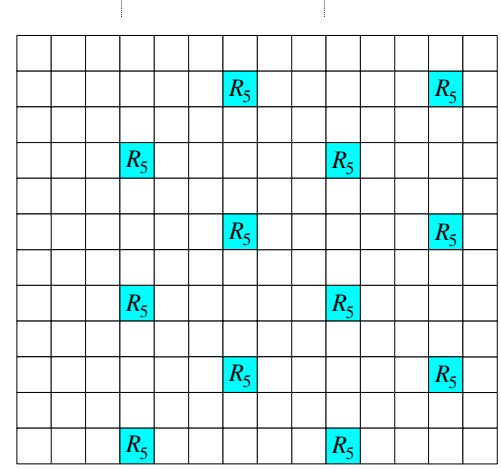

In Rel-9:

- UE-specific RS extended to dual-layer transmission
- CDM between RS of the two layers

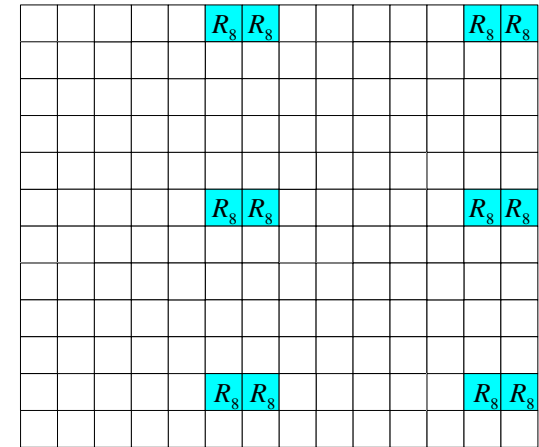
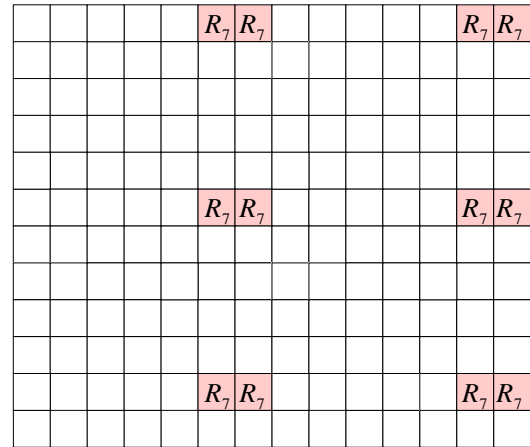



THE Mobile Broadband Standard

Downlink Channel Structure



- Flexible control design to avoid unnecessary overhead
 - Control region is first 1-3 OFDM symbols in each subframe (2-4 in narrow bandwidths)
 - Control region size (CFI: control channel format indicator) is dynamically variable
- Data transmission on Physical Downlink Shared Channel (PDSCH)

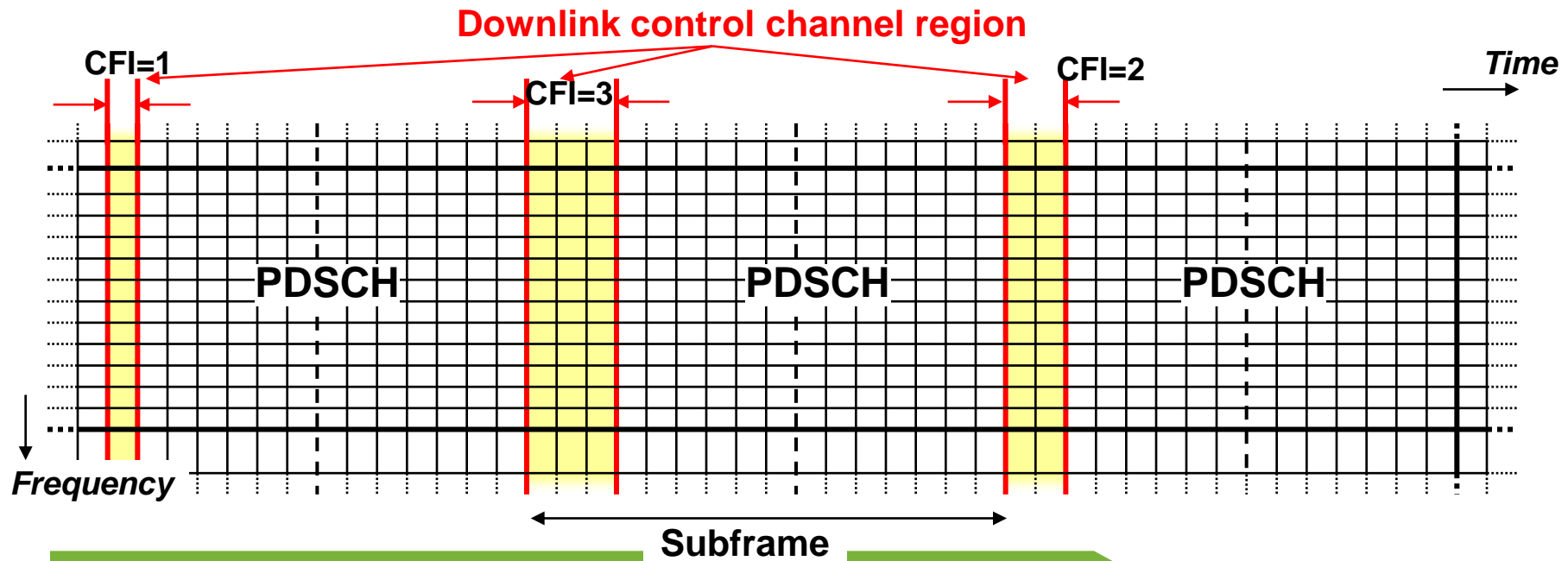



Downlink control signaling



 Physical Control Format Indicator Channel (**PCFICH**) indicates the control region size (CFI)

- Located in first OFDM symbol of each subframe
- PCFICH is designed to be robust
 - 16 QPSK symbols transmitted with full frequency diversity

 Physical Downlink Control Channel (**PDCCH**) carries Downlink Control Information (DCI) messages:

- downlink resource assignments
- uplink resource grants
- uplink power control commands

 Physical Hybrid ARQ Indicator Channel (**PHICH**) carries ACK/NACK for UL data transmissions

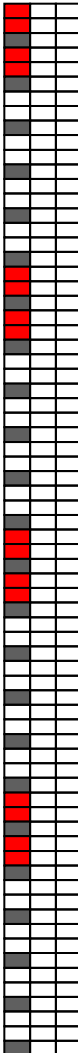



Downlink data transmission

- PDSCH carries user data, broadcast system information, paging messages
- Transmission resources are assigned dynamically by PDCCH
 - Localised (suitable for frequency domain scheduling) or
 - distributed (suitable for maximising frequency diversity)

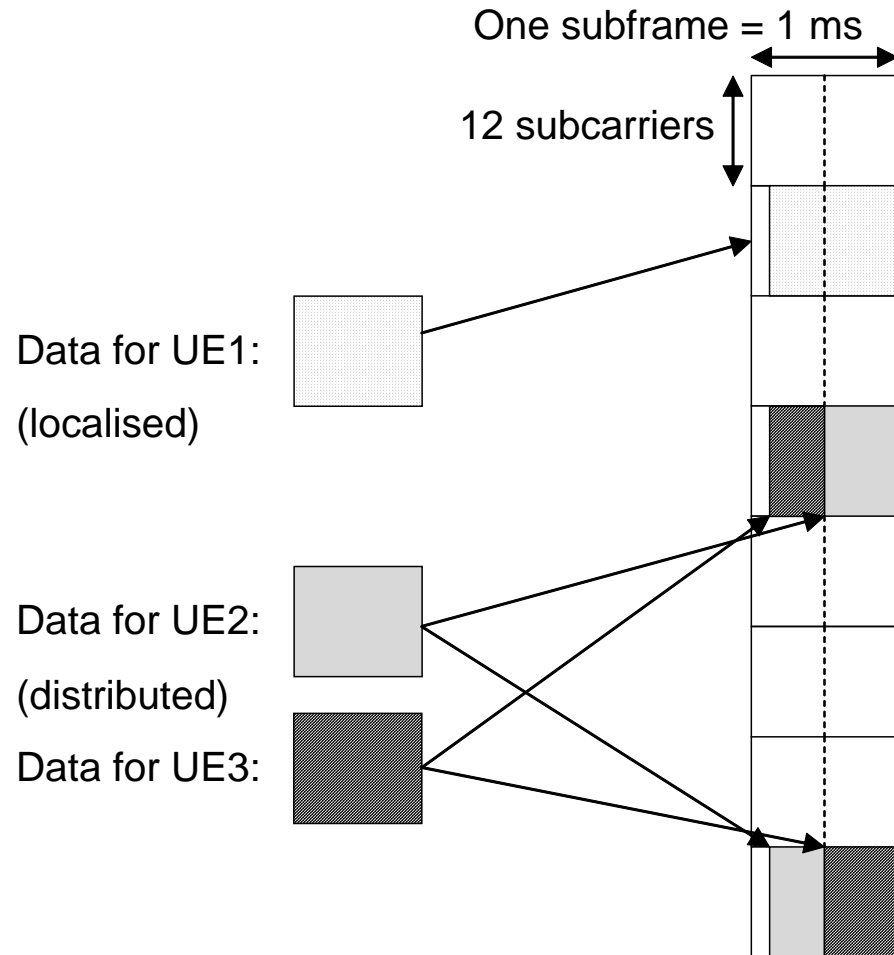



PDSCH transmission modes



 In Rel-9, each UE is configured in one of 8 “transmission modes” for PDSCH reception:





- Mode 1: Single antenna port, port 0
- Mode 2: Transmit diversity
- Mode 3: Open-loop spatial multiplexing
- Mode 4: Closed-loop spatial multiplexing
- Mode 5: MU-MIMO
- Mode 6: Closed-loop spatial multiplexing, single layer
- Mode 7: Single antenna port, UE-specific RS (port 5)
- Mode 8 (new in Rel-9): Single or dual-layer transmission with UE-specific RS (ports 7 and/or 8)

 (in each case, transmit diversity is also available as a fallback)



Contents



-  Introduction
-  Downlink Aspects for LTE Release 8
-  **Uplink Aspects for LTE Release 8**
-  Enhancements for LTE-Advanced (Release 10 and beyond)



Uplink multiple access: SC-FDMA

- Same parameterisation as downlink
- DFT precoding to ensure low PAPR / cubic metric
- Cyclic prefix facilitates frequency-domain equalisation at eNodeB

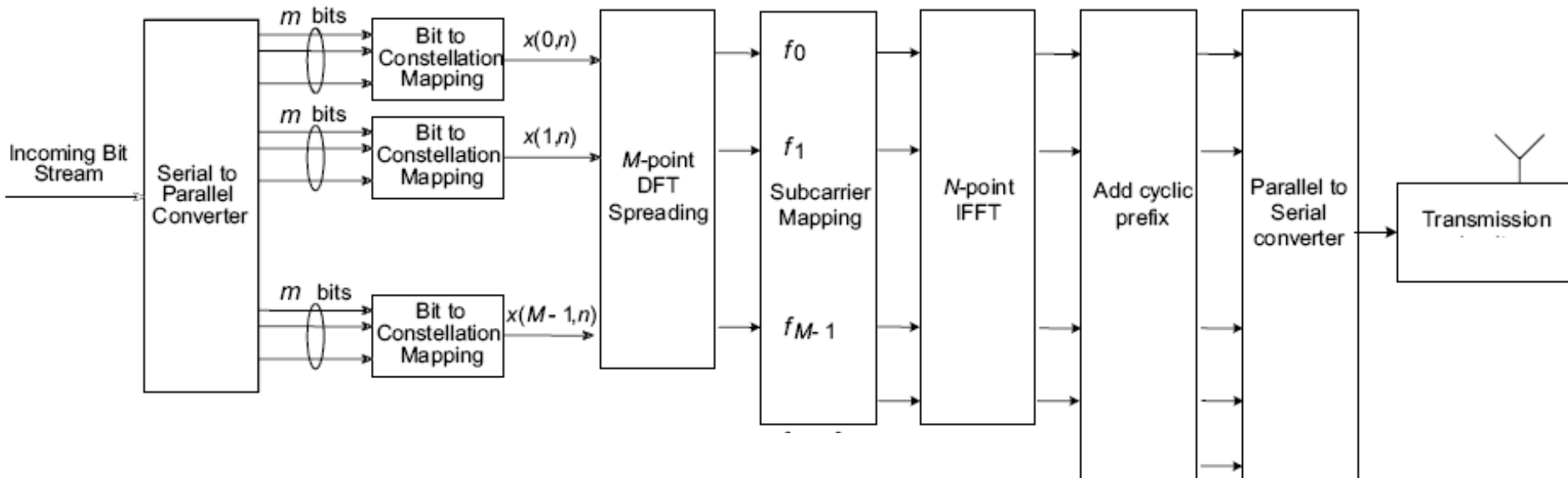



UL transmission resource allocation

- Same structure of PRBs in frequency domain as downlink
- Contiguous PRB allocation to keep single carrier property**
- Possibility to configure frequency hopping to increase frequency diversity
- Number of allocated PRBs for a given user in a given subframe is in multiples of 2, 3 and 5 for low-complexity DFT implementation

One subframe = 1 ms

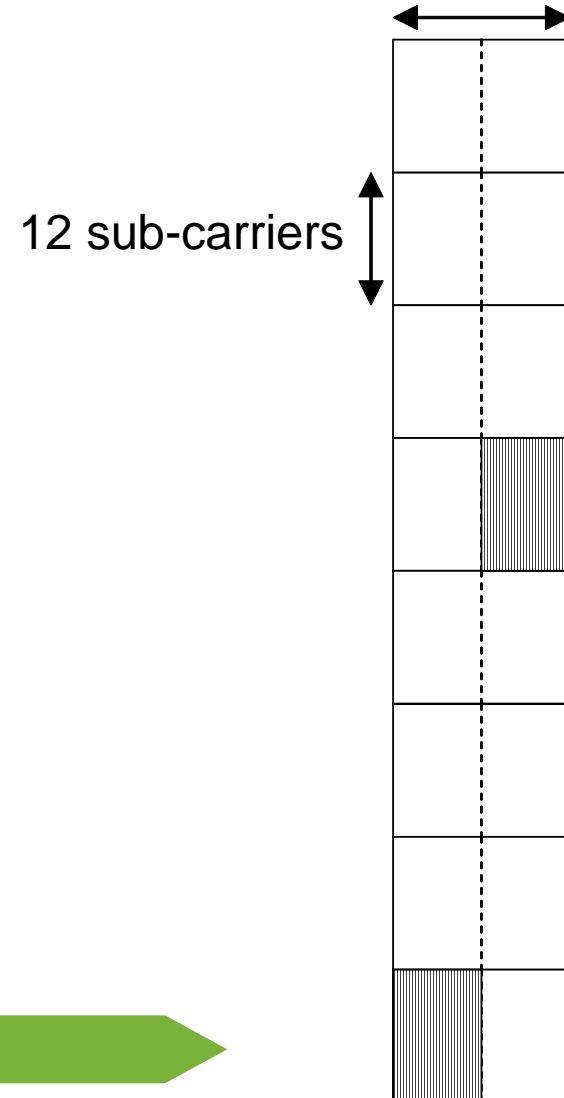



UL Reference Signals



Zadoff Chu sequences

- Excellent cross correlation property

Demodulation RS (DM RS)

- Same bandwidth as control / data transmission

Sounding RS (SRS)

- Supports:
 - UL frequency-domain scheduling
 - Channel sounding for downlink transmissions, especially for TDD
- Located In last symbol of a subframe
- Can be configured by network
- Uses interleaving in frequency domain (alternate subcarriers) to provide additional support for multiple users transmitting SRS in the same bandwidth



THE Mobile Broadband Standard

Uplink channel structure



Data transmissions on Physical Uplink Shared Channel (PUSCH)

- In centre of uplink bandwidth
- Minimises out-of-band emissions from wide-bandwidth data transmissions
- 1 transport block per TTI
- Same channel coding / rate matching as PDSCH
- Modulation QPSK, 16QAM, 64QAM

 When PUSCH is transmitted, any control signalling is multiplexed with data to maintain single carrier structure

 When no PUSCH, control signalling is on Physical Uplink Control Channel (PUCCH)

- Usually at edges of system bandwidth
- PUCCH hops from one side of the carrier to the other to maximise frequency diversity

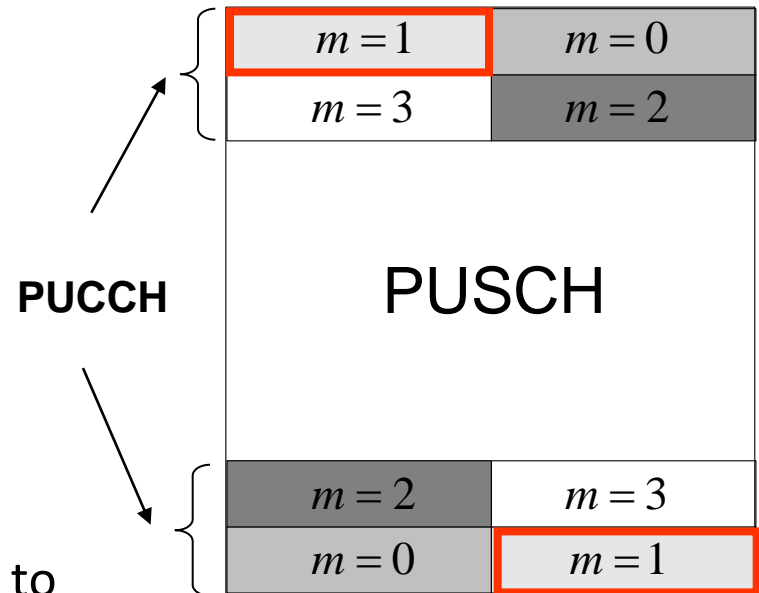

← One subframe →



Uplink Control Signalling



- ACK/NACK for PDSCH transmissions
- Scheduling Request (SR)
- Channel Quality Information feedback can be periodic on PUCCH or aperiodic on PUSCH
 - CQI – indicates an index of a Modulation / Coding Scheme (MCS) that could be received on PDSCH with $BLER \leq 0.1$
 - PMI – indicates preferred precoding matrix for PDSCH
 - RI – indicates number of useful transmission layers for PDSCH



Random Access Channel (RACH)

- RACH procedure begins with a preamble (PRACH)
- PRACH resources assigned by eNB within PUSCH region
- PRACH preamble fits into 6 PRBs
 - Sufficient for timing estimation
 - Invariant with bandwidth for low complexity
 - Zadoff Chu sequence
 - Excellent correlation properties
 - Zero correlation zone for different cyclic shifts
 - Flat frequency spectrum
 - Different sequences provided first by different cyclic shifts, then by different root sequences

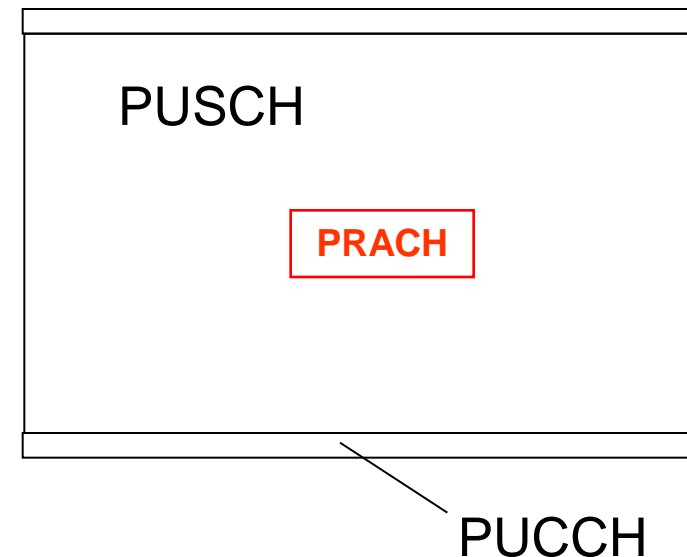

• Multiple PRACH formats suitable for different cell sizes



Timing Advance

- Uplink transmission orthogonality between users is maintained by timing advance
- Set initially during Random Access Procedure
- Updated as necessary subsequently
- Supports at least 100 km cell range
 - Greater ranges are up to the implementation

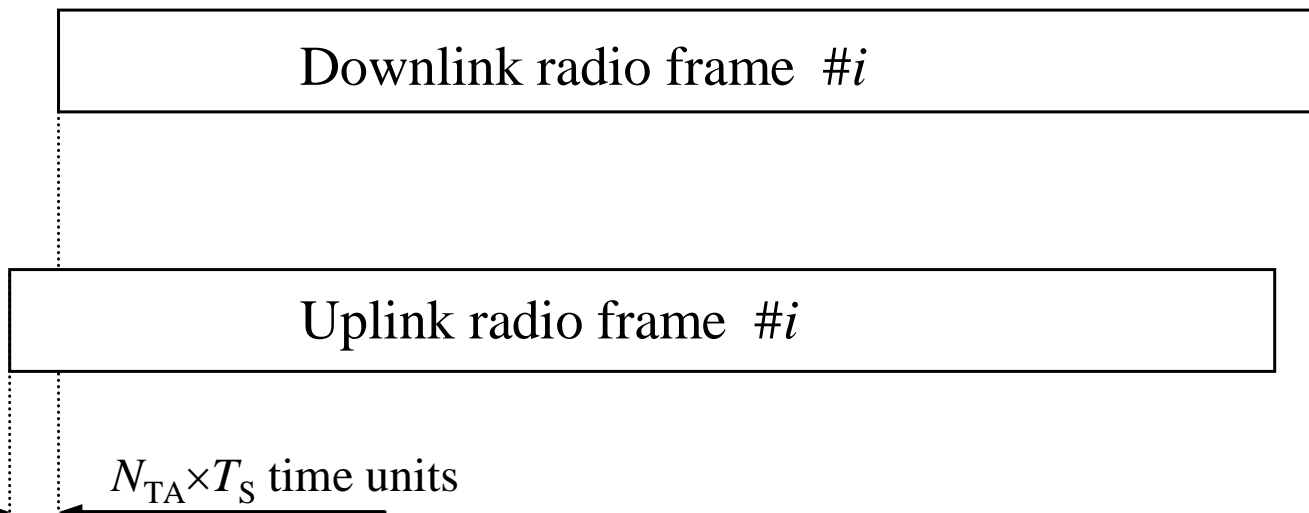



Uplink Power Control



- Controls uplink power spectral density
 - Total uplink transmit power scales linearly with transmitted bandwidth
- Fractional power control can compensate for all or part of path loss
 - Allows trade-off between intra-cell fairness and inter-cell interference
- MCS-specific offsets may be applied
- Closed-loop power control commands can fine-tune the power setting
 - Carried on PDCCH
 - Individual commands in UL resource grants
 - Group commands for groups of UEs
- Separate power control for PUCCH and PUSCH



UL Multi-Antenna transmission







Rel-8/9 supports:

- Switched antenna diversity
 - Closed-loop antenna switching supported by CRC masking on PBCH
- MU-MIMO
 - Different cyclic shifts of DM RS can be allocated to different UEs



Contents



-  Introduction
-  Downlink Aspects for LTE Release 8
-  Uplink Aspects for LTE Release 8
-  Enhancements for LTE-Advanced (Release 10 and beyond)



General Requirements



- 📶 LTE-Advanced is an evolution of LTE
- 📶 All relevant requirements of LTE are valid also for LTE-Advanced
- 📶 LTE-Advanced shall meet or exceed IMT-Advanced requirements within the ITU-R time plan
 - LTE-Advanced was approved as one of the IMT-Advanced RIT by ITU-R
- 📶 Targets of LTE-Advanced are adopted as long term targets

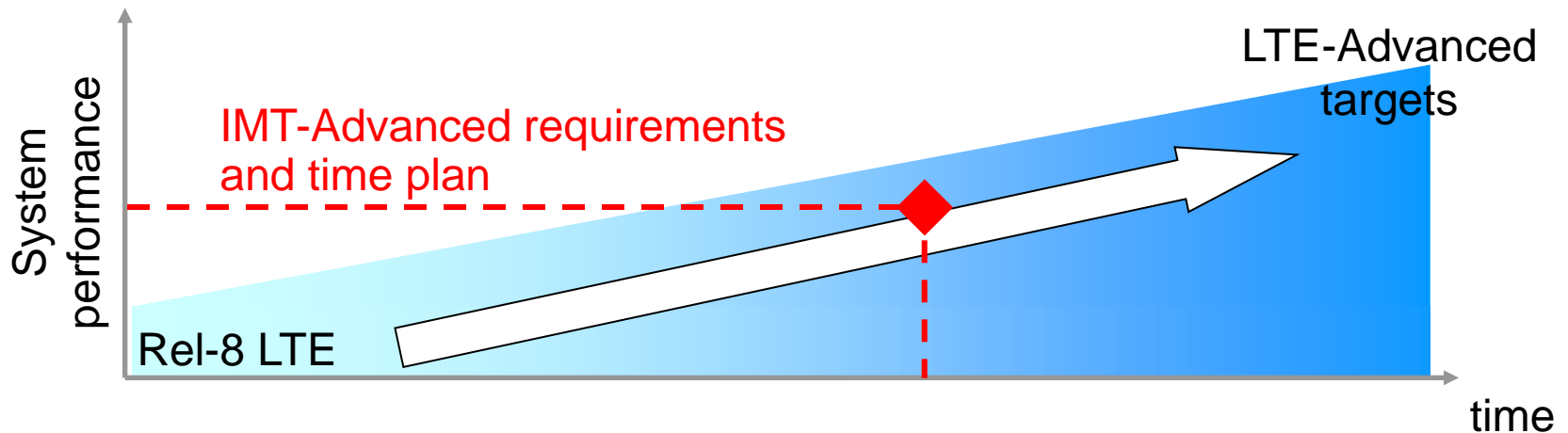



System Performance Requirements for LTE-Advanced



Peak data rate

- 1 Gbps data rate will be achieved by 4-by-4 MIMO and transmission bandwidth wider than approximately 70 MHz

Peak spectrum efficiency

- DL: Rel. 8 LTE satisfies IMT-Advanced requirement
- UL: Need to double from Release 8 to satisfy IMT-Advanced requirement

		Rel. 8 LTE	LTE-Advanced	IMT-Advanced
Peak data rate	DL	300 Mbps	1 Gbps	1 Gbps ^(*)
	UL	75 Mbps	500 Mbps	
Peak spectrum efficiency [bps/Hz]	DL	15	30	15
	UL	3.75	15	6.75

*“100 Mbps for high mobility and 1 Gbps for low mobility” is one of the key features as written in Circular Letter (CL)



System Performance Requirements for LTE-Advanced (cont'd)



Capacity and cell-edge user throughput

- Target for LTE-Advanced was set considering gain of 1.4 to 1.6 from Release 8 LTE performance

		Ant. Config.	Rel. 8 LTE*1	LTE-Advanced*2	IMT-Advanced*3
Capacity [bps/Hz/cell]	DL	2-by-2	1.69	2.4	-
		4-by-2	1.87	2.6	2.2
		4-by-4	2.67	3.7	-
	UL	1-by-2	0.74	1.2	-
		2-by-4	-	2.0	1.4
Cell-edge user throughput [bps/Hz/cell/user]	DL	2-by-2	0.05	0.07	-
		4-by-2	0.06	0.09	0.06
		4-by-4	0.08	0.12	-
	UL	1-by-2	0.024	0.04	-
		2-by-4	-	0.07	0.03

*1 See TR25.912(Case 1 scenario)

*2 See TR36.913(Case 1 scenario)

*3 See ITU-R M.2135(Base Coverage Urban scenario)



Deployment scenarios for LTE-Advanced



Target deployment scenarios for LTE-Advanced cover both homogeneous and heterogeneous networks.

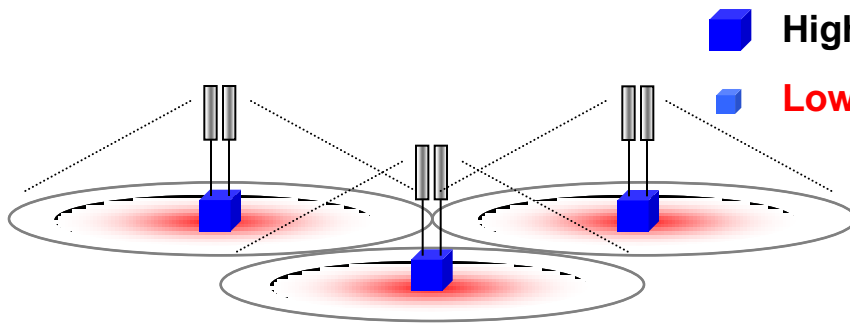

Homogeneous network deployment

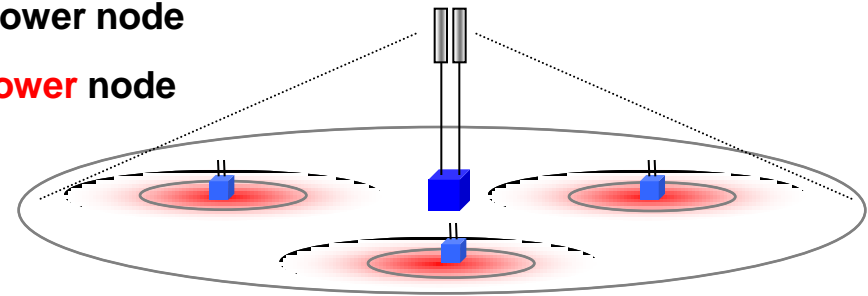

Heterogeneous network network

Evaluation models for each deployment scenario in 3GPP is shown in TR36.814 ver.9.0.0 (Annex therein)



Major Work Items for Release 10 LTE in RAN1



- Carrier aggregation for LTE
- Enhanced multi-antenna downlink transmission for LTE
- Uplink multiple antenna transmission for LTE
- Relays for LTE
- Enhanced ICIC for non-CA (carrier aggregation) based deployment of heterogeneous networks



Carrier Aggregation (CA)

- Wider bandwidth transmission using carrier aggregation for both DL and UL
- Entire system bandwidth up to, e.g., 100 MHz, comprises multiple basic frequency blocks called **component carriers (CCs)**
 - Satisfy requirements for peak data rate
- Each CC can be configured in a backward compatible way with Rel-8 LTE
 - Maintain backward compatibility with Rel-8 LTE
- Carrier aggregation supports both **contiguous and non-contiguous spectrum**, and **asymmetric bandwidth** for FDD
 - Achieve flexible spectrum usage

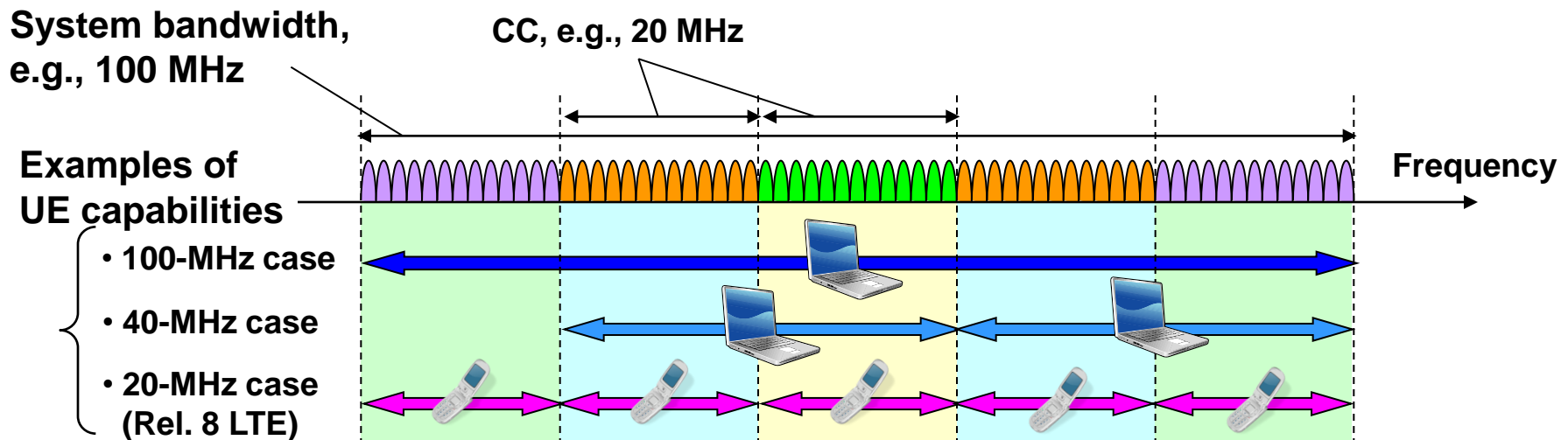



Enhanced Downlink Multi-antenna Transmission

- Extension up to 8-layer transmission
 - Increased from 4 layers in Rel-8/9
 - Satisfy the requirement for peak spectrum efficiency, i.e., 30 bps/Hz
- Additional reference signals (RS) specified:
 - Channel state information RS (CSI-RS)
 - For downlink channel sounding
 - Sparse, low overhead (configurable)
 - ✓ Density: 1 resource element (RE) per antenna port per PRB
 - UE-specific demodulation RS (DM-RS)
 - UE-specific DM-RS can be precoded, supporting non-codebook-based precoding,
 - applied 1-8-layer transmission, and enhanced multi-user beamforming, such as zero forcing (ZF)
 - DM RS pattern for higher numbers of layers is extended from 2-layer format for transmission mode 8 in Rel-9

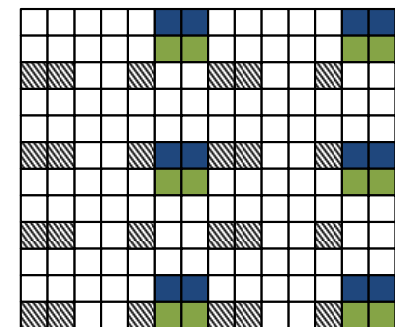
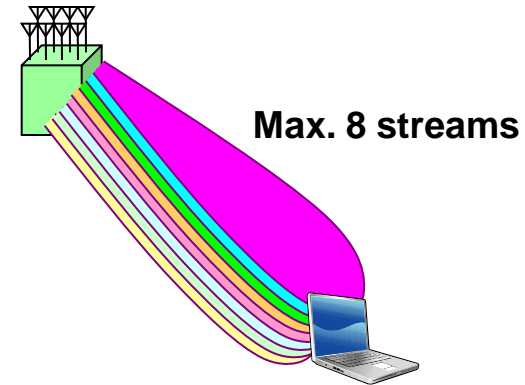

DMRS pattern



Enhanced Downlink Multi-antenna Transmission (Cont'd)



Enhanced Multi-user (MU) MIMO

- MU-MIMO dimensionality
 - Maximum spatial 4 layers
 - Maximum 2 layers per user

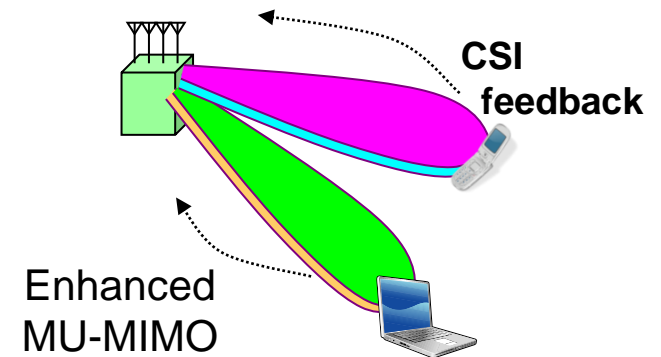

- CSI feedback enhancement using two matrix (W_1 , W_2) feedback frame work is now being studied
 - W_1 targets wideband/long-term channel properties
 - W_2 targets frequency-selective/short-term time channel properties
 - Matrix multiplication is used.



Enhanced Uplink Multi-antenna Transmission



- UL transmit diversity for PUCCH to improve robustness in cell-edge
 - Orthogonal resource transmit diversity is supported for PUCCH format 1 (Scheduling request) 1a/1b (HARQ-Ack) when UE has two Tx antennas
 - ✓ the same modulation symbol from the uplink channel is transmitted from two antenna ports, on two separate orthogonal resources.
- SU-MIMO up to 4-stream transmission to satisfy the requirement for peak spectrum efficiency, i.e., 15 bps/Hz
 - Closed-loop codebook based precoding supported

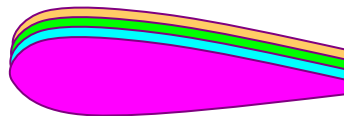
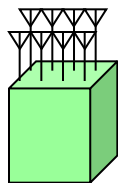

Max. 4 streams



SU-MIMO up to 4 streams



THE Mobile Broadband Standard

Relaying for LTE

Relay design target for Rel-10 is coverage extension

➔ Supports cell deployments in areas where wired backhaul is not available or very expensive

📶 “Type 1” relay

- Inband relaying: same carrier frequency for backhaul and access links
- Time division multiplexing of backhaul and access links
- Relay node (RN) creates a separate cell distinct from the donor cell
- UE receives/transmits control signals for scheduling and HARQ from/to RN
- RN appears as a Rel-8 LTE eNB to Rel-8 LTE UEs

📶 “Type 1a” relay

- Outband relaying: different carrier frequency for backhaul from access link

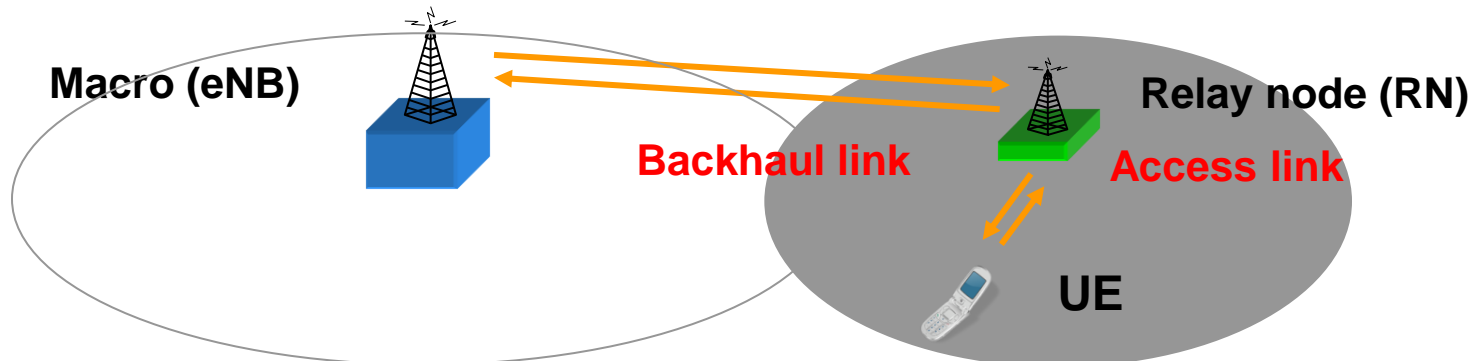



Conclusions



 LTE Rel.8 is now in commercial service phase.

- 20 commercial LTE NW launched
- 208 operators in 80 countries investing in LTE

 LTE-Advanced is a very flexible and advanced system

- Built on the established capabilities of the LTE Rel-8 and Rel-9 physical layer
- Further enhancements to exploit spectrum availability and advanced multi-antenna techniques

Thank You

Sadayuki Abeta
NTT DOCOMO



THE Mobile Broadband Standard

More Information about 3GPP:



www.3gpp.org

contact@3gpp.org